

**led.modular**

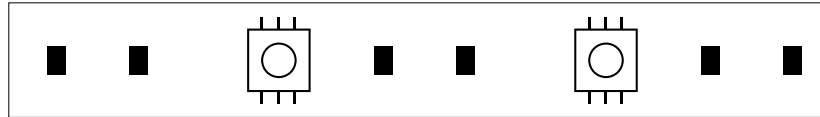
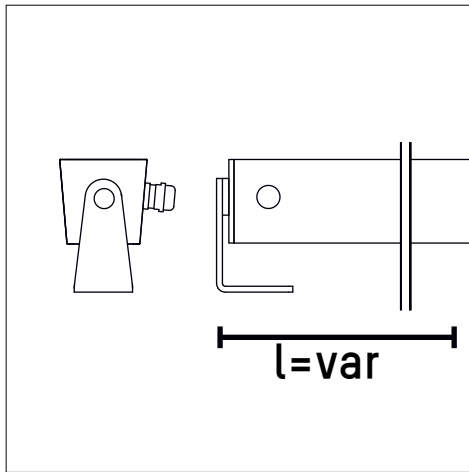

## Für Anstrahlzwecke im Aussenbereich

led.modular ist ein modular aufgebautes LED-Profilsystem.

Es bietet beinahe unbegrenzten Gestaltungsspielraum durch verschiedene Modul-Längen und einen großen Schwenkbereich von +/-90°.

Als linearer Fluter betont led.modular die Haptik der Architektur. Selbst feinste Oberflächenstrukturen werden sichtbar. In der kompakten Bauform - mit und ohne integriertem Betriebsgerät- kann led.modular als Spot zur akzentuierten Architekturbeleuchtung eingesetzt werden. Effektiv dank hoher Leistung bei niedrigem Stromverbrauch.

### Exterior spotlighting

led.modular is a modular LED profile system.

It offers virtually unlimited scope for design thanks to a range of module lengths and a large swivel range of +/-90°.

As a linear floodlight, led.modular emphasises the feel of the architecture. Even the finest surface structures are visible.

The compact design – with or without built-in control gear – means led.modular can be used as a spotlight for accentuated architectural lighting. Effect, with excellent output despite low electricity consumption.

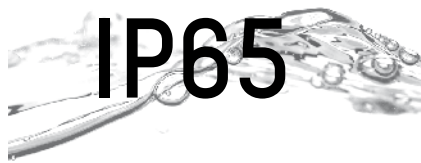

spot  
medium.spot  
flood  
oval.flood

### Lichttechnik

led.modular Profilleuchten gibt es in den Ausstrahlungs-Charakteristiken spot, medium und flood mit symmetrischer oder oval verzeichneter Lichtverteilung (oval.flood).

Die Leuchten sind in Ihrer Längsachse +/- 90° schwenkbar.

### Lighting technology

led.modular profile luminaires are available in spot, medium and flood characteristics with symmetrical or oval light distribution (oval flood).

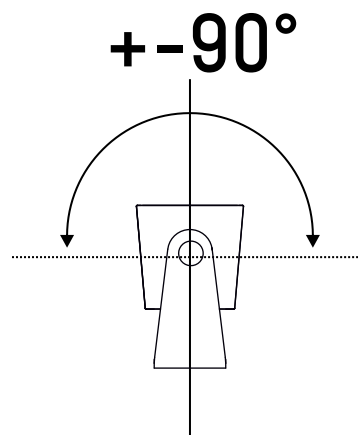

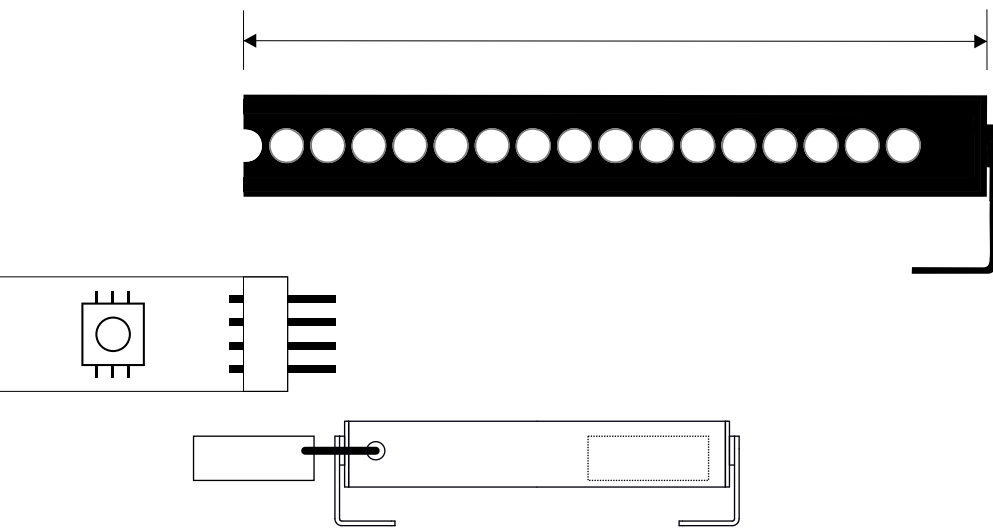

Mit integrierten und externen Betriebsgeräten  
With integrated and external driver units

## Modular

Zur Akzentuierung als Spot oder zur gleichflächigen Ausleuchtung als Fluter, led.modular bietet mit 6 Standardmodullängen für jede Planung die passende Leuchte. Leuchtenmodule in den Längen 231 und 411mm haben integrierte Betriebsgeräte. Für alle anderen Varianten können Sie die Zuordnung der passenden Betriebsgeräte der nachstehend angeführten Übersicht entnehmen.

## Modularity

For accenting as a spotlight or as a floodlight with even lighting, led.modular has 6 standard module lengths to provide the right luminaire to suit any plans. Luminaire modules in lengths 231 and 411mm have built-in control gear. For all other variants, you can find the allocation of the appropriate control gear in the overview below.

## Systemübersicht System overview

Länge / Length	231 mm	231 mm	411 mm	361 mm	661 mm	961 mm
Betriebsgerät (integriert) integrated ballast	X	X	X	-	-	-
Modulleistung 700 mA Module power 700 mA	7 W	10 W	15 W	25 W	50 W	75 W
Betriebsgerät/extern 700mA external ballast 700mA	-	-	-	117 091 ...	117 093 ...	117 095 ...
Modulleistung 350 mA Module power 350 mA	-	-	-	12 W	24 W	35 W
Betriebsgerät/extern 350mA external ballast 350mA	-	-	-	117 092 ...	117 092 ...	117 094 ...
Lichtverteilung Light distribution	rotations-symmetrisch axially symmetric	symmetrisch & bandförmig symmetric & asymmetric flat beam				
Ausstrahlungswinkel Beam angle	spot	spot medium flood oval.flood				

**Linearleuchte led.modular IP65**

- schwenkbar, mit Montagebügel
- zur Wand- oder Bodenmontage
- zur optimalen Ausleuchtung vertikaler Fassadenflächen
- mit LED
- L80/B10 (50.000 h), SDCM < 3
- rotationssymmetrische Lichtverteilung, narrow spot
- eingebautes LED-Betriebsgerät, elektronisch, 110-240 V, 50/60 Hz
- Anschlussleitung, 2000 mm, H05RN-F 3x1 mm<sup>2</sup>
- Gehäuse aus stranggepresstem Aluminium
- Sicherheitsglas, klar
- Befestigungsbügel aus Edelstahl
- Schutzart: IP65, Schutzklasse I
- 5 Jahre Hoffmeister Garantie
- Farbe: anthrazit, silber, weiß

**linear luminaire led.modular IP65**

- adjustable, with mounting bracket
- for installation on wall or ceiling
- for optimal illumination of vertical facades
- with LED
- L80/B10 (50.000 h), SDCM < 3
- rotationally symmetric light distribution, narrow spot
- integrated control gear, electronic, 110-240 V, 50/60 Hz
- supply cord, 2000 mm, H05RN-F 3x1 mm<sup>2</sup>
- housing of extruded aluminium profile
- safety glass, clear
- bracket of stainless steel
- protection rating: IP65, protection class I
- 5 years Hoffmeister warranty
- colour: anthracite, silver, white

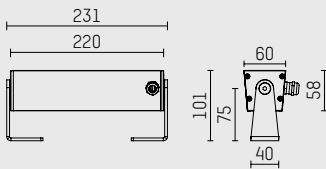
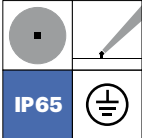

Länge / length	Leuchtmittel / lamp	Lichtstrom / lum. flux	Farbtemp. / colour temp.	Modulleistung / module power	CRI	Typ / type	Winkel / angle	Farbe / colour	Art.-Nr. / item-No.
231 mm	LED	350 lm	3000 K	7 W	90	narrow spot	5 °	anthrazit / anthracite	117 001 03 726
								silber / silver	117 001 03 916
								weiß / white	117 001 03 910
		400 lm	4000 K	7 W	>80	narrow spot	5 °	anthrazit / anthracite	117 001 04 726
								silber / silver	117 001 04 916
								weiß / white	117 001 04 910

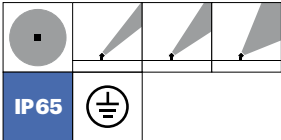

**Linearleuchte led.modular IP65**

- schwenkbar, mit Montagebügel
- zur Wand- oder Bodenmontage
- zur optimalen Ausleuchtung vertikaler Fassadenflächen
- mit LED
- L80/B10 (50.000 h), SDCM < 3
- symmetrische Lichtverteilung, spot - flood
- eingebautes LED-Betriebsgerät, elektronisch, 110-240 V, 50/60 Hz
- Anschlussleitung, 2000 mm, H05RN-F 3x1 mm²
- Gehäuse aus stranggepresstem Aluminium
- Sicherheitsglas, klar
- Befestigungsbügel aus Edelstahl
- Schutzart: IP65, Schutzklasse I
- 5 Jahre Hoffmeister Garantie
- Farbe: anthrazit, silber, weiß

**linear luminaire led.modular IP65**

- adjustable, with mounting bracket
- for installation on wall or ceiling
- for optimal illumination of vertical facades
- with LED
- L80/B10 (50.000 h), SDCM < 3
- symmetrical light distribution, spot - flood
- integrated control gear, electronic, 110-240 V, 50/60 Hz
- supply cord, 2000 mm, H05RN-F 3x1 mm²
- housing of extruded aluminium profile
- safety glass, clear
- bracket of stainless steel
- protection rating: IP65, protection class I
- 5 years Hoffmeister warranty
- colour: anthracite, silver, white

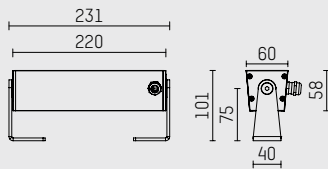

Länge / length	Leuchtmittel / lamp	Lichtstrom / lum. flux	Farbtemp. / colour temp.	Modulleistung / module power	CRI	Typ / type	Winkel / angle	Farbe / colour	Art.-Nr. / item-No.	
231 mm	LED	700 lm	3000 K	10 W	90	spot	10 °	anthrazit / anthracite	117 012 03 726	
								silber / silver	117 012 03 916	
								weiß / white	117 012 03 910	
			800 lm	4000 K	10 W	>80	spot	10 °	anthrazit / anthracite	117 012 04 726
									silber / silver	117 012 04 916
									weiß / white	117 012 04 910
			700 lm	3000 K	10 W	90	medium	25 °	anthrazit / anthracite	117 014 03 726
									silber / silver	117 014 03 916
									weiß / white	117 014 03 910
			800 lm	4000 K	10 W	>80	medium	25 °	anthrazit / anthracite	117 014 04 726
									silber / silver	117 014 04 916
									weiß / white	117 014 04 910
		700 lm	3000 K	10 W	90	flood	45 °	anthrazit / anthracite	117 015 03 726	
								silber / silver	117 015 03 916	
								weiß / white	117 015 03 910	
		800 lm	4000 K	10 W	>80	flood	45 °	anthrazit / anthracite	117 015 04 726	
								silber / silver	117 015 04 916	
								weiß / white	117 015 04 910	

**Linearleuchte led.modular IP65**

- schwenkbar, mit Montagebügel
- zur Wand- oder Bodenmontage
- zur optimalen Ausleuchtung vertikaler Fassadenflächen
- mit LED
- L80/B10 (50.000 h), SDCM < 3
- symmetrische Lichtverteilung, spot - flood
- eingebautes LED-Betriebsgerät, elektronisch, 220-240 V, 50/60 Hz
- Anschlussleitung, 2000 mm, H05RN-F 3x1 mm<sup>2</sup>
- Gehäuse aus stranggepresstem Aluminium
- Sicherheitsglas, klar
- Befestigungsbügel aus Edelstahl
- Schutzart: IP65, Schutzklasse I
- 5 Jahre Hoffmeister Garantie
- Farbe: anthrazit, silber, weiß

**linear luminaire led.modular IP65**

- adjustable, with mounting bracket
- for installation on wall or ceiling
- for optimal illumination of vertical facades
- with LED
- L80/B10 (50.000 h), SDCM < 3
- symmetrical light distribution, spot - flood
- integrated control gear, electronic, 220-240 V, 50/60 Hz
- supply cord, 2000 mm, H05RN-F 3x1 mm<sup>2</sup>
- housing of extruded aluminium profile
- safety glass, clear
- bracket of stainless steel
- protection rating: IP65, protection class I
- 5 years Hoffmeister warranty
- colour: anthracite, silver, white

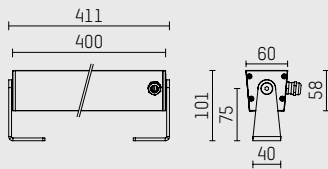
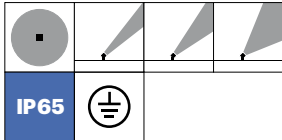

Länge / length	Leuchtmittel / lamp	Lichtstrom / lum. flux	Farbtemp. / colour temp.	Modulleistung / module power	CRI	Typ / type	Winkel / angle	Farbe / colour	Art.-Nr. / item.-No.	
411 mm	LED	1100 lm	3000 K	15 W	90	spot	10 °	anthrazit / anthracite	117 022 03 726	
								silber / silver	117 022 03 916	
								weiß / white	117 022 03 910	
			1200 lm	4000 K	15 W	>80	spot	10 °	anthrazit / anthracite	117 022 04 726
									silber / silver	117 022 04 916
									weiß / white	117 022 04 910
			1100 lm	3000 K	15 W	90	medium	25 °	anthrazit / anthracite	117 024 03 726
									silber / silver	117 024 03 916
									weiß / white	117 024 03 910
		1200 lm	4000 K	15 W	>80	medium	25 °	anthrazit / anthracite	117 024 04 726	
								silber / silver	117 024 04 916	
								weiß / white	117 024 04 910	
		1100 lm	3000 K	15 W	90	flood	45 °	anthrazit / anthracite	117 025 03 726	
								silber / silver	117 025 03 916	
								weiß / white	117 025 03 910	
		1200 lm	4000 K	15 W	>80	flood	45 °	anthrazit / anthracite	117 025 04 726	
								silber / silver	117 025 04 916	
								weiß / white	117 025 04 910	

Oval-flood

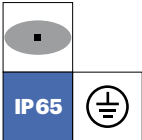

**Linearleuchte led.modular IP65**

- schwenkbar, mit Montagebügel
- zur Wand- oder Bodenmontage
- zur optimalen Ausleuchtung vertikaler Fassadenflächen
- mit LED
- L80/B10 (50.000 h), SDCM < 3
- bisymmetrische Lichtverteilung, oval-flood
- eingebautes LED-Betriebsgerät, elektronisch, 110-240 V, 50/60 Hz
- Anschlussleitung, 2000 mm, H05RN-F 3x1 mm²
- Gehäuse aus stranggepresstem Aluminium
- Sicherheitsglas, klar
- Befestigungsbügel aus Edelstahl
- Schutzart: IP65, Schutzklasse I
- 5 Jahre Hoffmeister Garantie
- Farbe: anthrazit, silber, weiß

**linear luminaire led.modular IP65**

- adjustable, with mounting bracket
- for installation on wall or ceiling
- for optimal illumination of vertical facades
- with LED
- L80/B10 (50.000 h), SDCM < 3
- bisymmetrical light distribution, oval-flood
- integrated control gear, electronic, 110-240 V, 50/60 Hz
- supply cord, 2000 mm, H05RN-F 3x1 mm²
- housing of extruded aluminium profile
- safety glass, clear
- bracket of stainless steel
- protection rating: IP65, protection class I
- 5 years Hoffmeister warranty
- colour: anthracite, silver, white

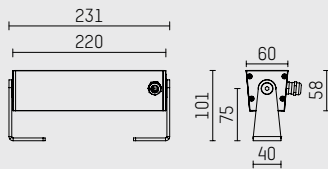

Länge / length	Leuchtmittel / lamp	Lichtstrom / lum. lux	Farbtemp. / colour temp.	Modulleistung / module power	CRI	Farbe / colour	Art.-Nr. / item-No.
231 mm	LED	700 lm	3000 K	10 W	90	anthrazit / anthracite	117 016 03 726
						silber / silver	117 016 03 916
						weiß / white	117 016 03 910
		800 lm	4000 K	10 W	>80	anthrazit / anthracite	117 016 04 726
						silber / silver	117 016 04 916
						weiß / white	117 016 04 910

led.modular



Oval-flood



**Linearleuchte led.modular IP65**

- schwenkbar, mit Montagebügel
- zur Wand- oder Bodenmontage
- zur optimalen Ausleuchtung vertikaler Fassadenflächen
- mit LED
- L80/B10 (50.000 h), SDCM < 3
- bisymmetrische Lichtverteilung, oval-flood
- eingebautes LED-Betriebsgerät, elektronisch, 220-240 V, 50/60 Hz
- Anschlussleitung, 2000 mm, H05RN-F 3x1 mm²
- Gehäuse aus stranggepresstem Aluminium
- Sicherheitsglas, klar
- Befestigungsbügel aus Edelstahl
- Schutzart: IP65, Schutzklasse I
- 5 Jahre Hoffmeister Garantie
- Farbe: anthrazit, silber, weiß

**linear luminaire led.modular IP65**

- adjustable, with mounting bracket
- for installation on wall or ceiling
- for optimal illumination of vertical facades
- with LED
- L80/B10 (50.000 h), SDCM < 3
- bisymmetrical light distribution, oval-flood
- integrated control gear, electronic, 220-240 V, 50/60 Hz
- supply cord, 2000 mm, H05RN-F 3x1 mm²
- housing of extruded aluminium profile
- safety glass, clear
- bracket of stainless steel
- protection rating: IP65, protection class I
- 5 years Hoffmeister warranty
- colour: anthracite, silver, white

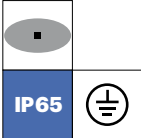

led.modular

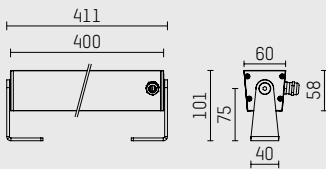

Länge / length	Leuchtmittel / lamp	Lichtstrom / lum. flux	Farbtemp. / colour temp.	Modulleistung / module power	CRI	Farbe / colour	Art.-Nr. / item-No.
411 mm	LED	1100 lm	3000 K	15 W	90	anthrazit / anthracite	117 026 03 726
						silber / silver	117 026 03 916
						weiß / white	117 026 03 910
		1200 lm	4000 K	15 W	>80	anthrazit / anthracite	117 026 04 726
						silber / silver	117 026 04 916
						weiß / white	117 026 04 910

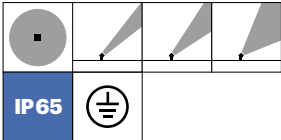

**Linearleuchte led.modular IP65**

- schwenkbar, mit Montagebügel
- zur Wand- oder Bodenmontage
- zur optimalen Ausleuchtung vertikaler Fassadenflächen
- mit LED
- L80/B10 (50.000 h), SDCM < 3
- symmetrische Lichtverteilung, spot - flood
- 10° / 25° / 45° Ausstrahlungswinkel
- LED-Platine temperaturüberwacht (NTC) für LED-Betriebsgerät (s. Zubehör)
- Optional: Reduzierung der Systemleistung und des Lichtstroms auf ca. 50 % möglich
- Anschlussleitung, Länge: 2000 mm
- Gehäuse aus stranggepresstem Aluminium
- Sicherheitsglas, klar
- Befestigungsbügel aus Edelstahl
- Schutzart: IP65, Schutzklasse I
- 5 Jahre Hoffmeister Garantie
- Farbe: anthrazit, silber, weiß

**linear luminaire led.modular IP65**

- adjustable, with mounting bracket
- for installation on wall or ceiling
- for optimal illumination of vertical facades
- with LED
- L80/B10 (50.000 h), SDCM < 3
- symmetrical light distribution, spot - flood
- 10° / 25° / 45° beam angle
- temperature-controlled LED circuit board (NTC) for LED-control gear (s. accessories)
- optional: Reduction of system power and luminous flux to approx. 50 % is possible
- supply cord, length: 2000 mm
- housing of extruded aluminium profile
- safety glass, clear
- bracket of stainless steel
- protection rating: IP65, protection class I
- 5 years Hoffmeister warranty
- colour: anthracite, silver, white

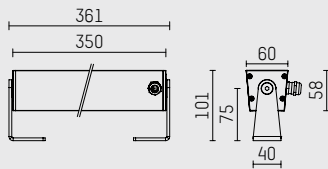

Länge / length	Leuchtmittel / lamp	Lichtstrom / lum. flux	Farbtemp. / colour temp.	Modulleistung / module power	CRI	Typ / type	Winkel / angle	Farbe / colour	Art.-Nr. / item.-No.	
361 mm	LED	2150/1250 lm	3000 K	25/12 W	90	spot	10 °	anthrazit / anthracite	117 032 03 726	
								silber / silver	117 032 03 916	
								weiß / white	117 032 03 910	
		2400/1350 lm	4000 K	25/12 W	>80	spot	10 °	anthrazit / anthracite	117 032 04 726	
								silber / silver	117 032 04 916	
								weiß / white	117 032 04 910	
	2150/1250 lm	LED	3000 K	25/12 W	90	medium	25 °	anthrazit / anthracite	117 034 03 726	
								silber / silver	117 034 03 916	
								weiß / white	117 034 03 910	
			2400/1350 lm	4000 K	25/12 W	>80	medium	25 °	anthrazit / anthracite	117 034 04 726
									silber / silver	117 034 04 916
									weiß / white	117 034 04 910
2150/1250 lm	LED	3000 K	25/12 W	90	flood	45 °	anthrazit / anthracite	117 035 03 726		
							silber / silver	117 035 03 916		
							weiß / white	117 035 03 910		
		2400/1350 lm	4000 K	25/12 W	>80	flood	45 °	anthrazit / anthracite	117 035 04 726	
								silber / silver	117 035 04 916	
								weiß / white	117 035 04 910	



**Linearleuchte led.modular IP65**

- schwenkbar, mit Montagebügel
- zur Wand- oder Bodenmontage
- zur optimalen Ausleuchtung vertikaler Fassadenflächen
- mit LED
- L80/B10 (50.000 h), SDCM < 3
- symmetrische Lichtverteilung, spot - flood
- 10° / 25° / 45° Ausstrahlungswinkel
- LED-Platine temperaturüberwacht (NTC) für LED-Betriebsgerät (s. Zubehör)
- Optional: Reduzierung der Systemleistung und des Lichtstroms auf ca. 50 % möglich
- Anschlussleitung, Länge: 2000 mm
- Gehäuse aus stranggepresstem Aluminium
- Sicherheitsglas, klar
- Befestigungsbügel aus Edelstahl
- Schutzart: IP65, Schutzklasse I
- 5 Jahre Hoffmeister Garantie
- Farbe: anthrazit, silber, weiß

**linear luminaire led.modular IP65**

- adjustable, with mounting bracket
- for installation on wall or ceiling
- for optimal illumination of vertical facades
- with LED
- L80/B10 (50.000 h), SDCM < 3
- symmetrical light distribution, spot - flood
- 10° / 25° / 45° beam angle
- temperature-controlled LED circuit board (NTC) for LED-control gear (s. accessories)
- optional: Reduction of system power and luminous flux to approx. 50 % ist possible
- supply cord, length: 2000 mm
- housing of extruded aluminium profile
- safety glass, clear
- bracket of stainless steel
- protection rating: IP65, protection class I
- 5 years Hoffmeister warranty
- colour: anthracite, silver, white

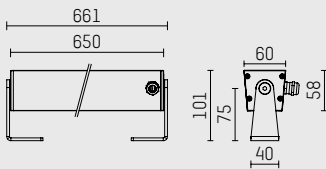
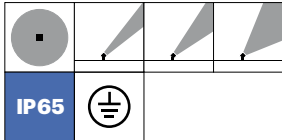

Länge / length	Leuchtmittel / lamp	Lichtstrom / lum. flux	Farbtemp. / colour temp.	Modulleistung / module power	CRI	Typ / type	Winkel / angle	Farbe / colour	Art.-Nr. / item.-No.
661 mm	LED	4200/2400 lm	3000 K	50/24 W	90	spot	10 °	anthrazit / anthracite	117 042 03 726
								silber / silver	117 042 03 916
								weiß / white	117 042 03 910
	4800/2650 lm	4000 K	50/24 W	>80	spot	10 °	anthrazit / anthracite	117 042 04 726	
							silber / silver	117 042 04 916	
							weiß / white	117 042 04 910	
	4200/2400 lm	3000 K	50/24 W	90	medium	25 °	anthrazit / anthracite	117 044 03 726	
							silber / silver	117 044 03 916	
							weiß / white	117 044 03 910	
4800/2650 lm	4000 K	50/24 W	>80	medium	25 °	anthrazit / anthracite	117 044 04 726		
						silber / silver	117 044 04 916		
						weiß / white	117 044 04 910		
4200/2400 lm	3000 K	50/24 W	90	flood	45 °	anthrazit / anthracite	117 045 03 726		
						silber / silver	117 045 03 916		
						weiß / white	117 045 03 910		
4800/2650 lm	4000 K	50/24 W	>80	flood	45 °	anthrazit / anthracite	117 045 04 726		
						silber / silver	117 045 04 916		
						weiß / white	117 045 04 910		

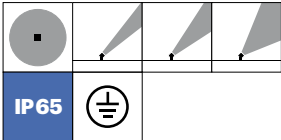

**Linearleuchte led.modular IP65**

- schwenkbar, mit Montagebügel
- zur Wand- oder Bodenmontage
- zur optimalen Ausleuchtung vertikaler Fassadenflächen
- mit LED
- L80/B10 (50.000 h), SDCM < 3
- symmetrische Lichtverteilung, spot - flood
- 10° / 25° / 45° Ausstrahlungswinkel
- LED-Platine temperaturüberwacht (NTC) für LED-Betriebsgerät (s. Zubehör)
- Anschlussleitung, Länge: 2000 mm
- Gehäuse aus stranggepresstem Aluminium
- Sicherheitsglas, klar
- Befestigungsbügel aus Edelstahl
- Schutzart: IP65, Schutzklasse I
- 5 Jahre Hoffmeister Garantie
- Farbe: anthrazit, silber, weiß

**linear luminaire led.modular IP65**

- adjustable, with mounting bracket
- for installation on wall or ceiling
- for optimal illumination of vertical facades
- with LED
- L80/B10 (50.000 h), SDCM < 3
- symmetrical light distribution, spot - flood
- 10° / 25° / 45° beam angle
- temperature-controlled LED circuit board (NTC) for LED-control gear (s. accessories)
- supply cord, length: 2000 mm
- housing of extruded aluminium profile
- safety glass, clear
- bracket of stainless steel
- protection rating: IP65, protection class I
- 5 years Hoffmeister warranty
- colour: anthracite, silver, white

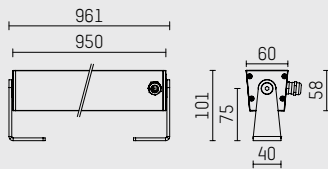

Länge / length	Leuchtmittel / lamp	Lichtstrom / lum. flux	Farbtemp. / colour temp.	Modulleistung / module power	CRI	Typ / type	Winkel / angle	Farbe / colour	Art.-Nr. / item-No.	
961 mm	LED	6300/3650 lm	3000 K	75/35 W	90	spot	10 °	anthrazit / anthracite	117 052 03 726	
								silber / silver	117 052 03 916	
								weiß / white	117 052 03 910	
		7200/4150 lm	4000 K	75/35 W	>80	spot	10 °	anthrazit / anthracite	117 052 04 726	
								silber / silver	117 052 04 916	
								weiß / white	117 052 04 910	
	6300/3650 lm	LED	6300/3650 lm	3000 K	75/35 W	90	medium	25 °	anthrazit / anthracite	117 054 03 726
									silber / silver	117 054 03 916
									weiß / white	117 054 03 910
			7200/4150 lm	4000 K	75/35 W	>80	medium	25 °	anthrazit / anthracite	117 054 04 726
									silber / silver	117 054 04 916
									weiß / white	117 054 04 910
6300/3650 lm	LED	6300/3650 lm	3000 K	75/35 W	90	flood	45 °	anthrazit / anthracite	117 055 03 726	
								silber / silver	117 055 03 916	
								weiß / white	117 055 03 910	
		7200/4150 lm	4000 K	75/35 W	>80	flood	45 °	anthrazit / anthracite	117 055 04 726	
								silber / silver	117 055 04 916	
								weiß / white	117 055 04 910	

Oval-flood

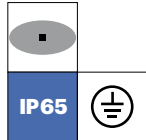

**Linearleuchte led.modular IP65**

- schwenkbar, mit Montagebügel
- zur Wand- oder Bodenmontage
- zur optimalen Ausleuchtung vertikaler Fassadenflächen
- mit LED
- L80/B10 (50.000 h), SDCM < 3
- bisymmetrische Lichtverteilung, oval-flood
- LED-Platine temperaturüberwacht (NTC) für LED-Betriebsgerät (s. Zubehör)
- Optional: Reduzierung der Systemleistung und des Lichtstroms auf ca. 50 % möglich
- Anschlussleitung, Länge: 2000 mm
- Gehäuse aus stranggepresstem Aluminium
- Sicherheitsglas, klar
- Befestigungsbügel aus Edelstahl
- Schutzart: IP65, Schutzklasse I
- 5 Jahre Hoffmeister Garantie
- Farbe: anthrazit, silber, weiß

**linear luminaire led.modular IP65**

- adjustable, with mounting bracket
- for installation on wall or ceiling
- for optimal illumination of vertical facades
- with LED
- L80/B10 (50.000 h), SDCM < 3
- bisymmetrical light distribution, oval-flood
- temperature-controlled LED circuit board (NTC) for LED-control gear (s. accessories)
- optional: Reduction of system power and luminous flux to approx. 50 % is possible
- supply cord, length: 2000 mm
- housing of extruded aluminium profile
- safety glass, clear
- bracket of stainless steel
- protection rating: IP65, protection class I
- 5 years Hoffmeister warranty
- colour: anthracite, silver, white

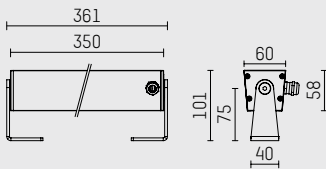

Länge / length	Leuchtmittel / lamp	Lichtstrom / lum. flux	Farbtemp. / colour temp.	Modulleistung / module power	CRI	Farbe / colour	Art.-Nr. / item-No.
361 mm	LED	2150/1250 lm	3000 K	25/12 W	90	anthrazit / anthracite	117 036 03 726
						silber / silver	117 036 03 916
						weiß / white	117 036 03 910
		2400/1350 lm	4000 K	25/12 W	>80	anthrazit / anthracite	117 036 04 726
						silber / silver	117 036 04 916
						weiß / white	117 036 04 910

Oval-flood

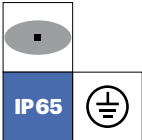

**Linearleuchte led.modular IP65**

- schwenkbar, mit Montagebügel
- zur Wand- oder Bodenmontage
- zur optimalen Ausleuchtung vertikaler Fassadenflächen
- mit LED
- L80/B10 (50.000 h), SDCM < 3
- bisymmetrische Lichtverteilung, oval-flood
- LED-Platine temperaturüberwacht (NTC) für LED-Betriebsgerät (s. Zubehör)
- Optional: Reduzierung der Systemleistung und des Lichtstroms auf ca. 50 % möglich
- Anschlussleitung, Länge: 2000 mm
- Gehäuse aus stranggepresstem Aluminium
- Sicherheitsglas, klar
- Befestigungsbügel aus Edelstahl
- Schutzart: IP65, Schutzklasse I
- 5 Jahre Hoffmeister Garantie
- Farbe: anthrazit, silber, weiß

**linear luminaire led.modular IP65**

- adjustable, with mounting bracket
- for installation on wall or ceiling
- for optimal illumination of vertical facades
- with LED
- L80/B10 (50.000 h), SDCM < 3
- bisymmetrical light distribution, oval-flood
- temperature-controlled LED circuit board (NTC) for LED-control gear (s. accessories)
- optional: Reduction of system power and luminous flux to approx. 50 % is possible
- supply cord, length: 2000 mm
- housing of extruded aluminium profile
- safety glass, clear
- bracket of stainless steel
- protection rating: IP65, protection class I
- 5 years Hoffmeister warranty
- colour: anthracite, silver, white

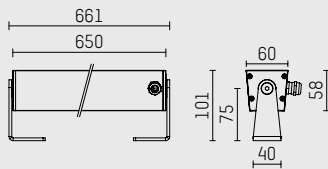

Länge / length	Leuchtmittel / lamp	Lichtstrom / lum. flux	Farbtemp. / colour temp.	Modulleistung / module power	CRI	Farbe / colour	Art.-Nr. / item-No.
661 mm	LED	4200/2400 lm	3000 K	50/24 W	90	anthrazit / anthracite	117 046 03 726
						silber / silver	117 046 03 916
						weiß / white	117 046 03 910
		4800/2650 lm	4000 K	50/24 W	>80	anthrazit / anthracite	117 046 04 726
						silber / silver	117 046 04 916
						weiß / white	117 046 04 910

Oval-flood

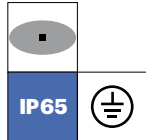

**Linearleuchte led.modular IP65**

- schwenkbar, mit Montagebügel
- zur Wand- oder Bodenmontage
- zur optimalen Ausleuchtung vertikaler Fassadenflächen
- mit LED
- L80/B10 (50.000 h), SDCM < 3
- bisymmetrische Lichtverteilung, oval-flood
- LED-Platine temperaturüberwacht (NTC) für LED-Betriebsgerät (s. Zubehör)
- Anschlussleitung, Länge: 2000 mm
- Gehäuse aus stranggepresstem Aluminium
- Sicherheitsglas, klar
- Befestigungsbügel aus Edelstahl
- Schutzart: IP65, Schutzklasse I
- 5 Jahre Hoffmeister Garantie
- Farbe: anthrazit, silber, weiß

**linear luminaire led.modular IP65**

- adjustable, with mounting bracket
- for installation on wall or ceiling
- for optimal illumination of vertical facades
- with LED
- L80/B10 (50.000 h), SDCM < 3
- bisymmetrical light distribution, oval-flood
- temperature-controlled LED circuit board (NTC) for LED-control gear (s. accessories)
- supply cord, length: 2000 mm
- housing of extruded aluminium profile
- safety glass, clear
- bracket of stainless steel
- protection rating: IP65, protection class I
- 5 years Hoffmeister warranty
- colour: anthracite, silver, white

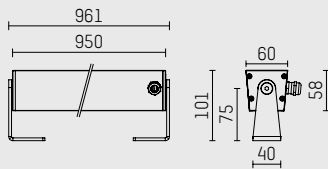

Länge / length	Leuchtmittel / lamp	Lichtstrom / lum. flux	Farbtemp. / colour temp.	Modulleistung / module power	CRI	Farbe / colour	Art.-Nr. / item-No.
961 mm	LED	6300/3650 lm	3000 K	75/35 W	90	anthrazit / anthracite	117 056 03 726
						silber / silver	117 056 03 916
						weiß / white	117 056 03 910
		7200/4150 lm	4000 K	75/35 W	>80	anthrazit / anthracite	117 056 04 726
						silber / silver	117 056 04 916
						weiß / white	117 056 04 910

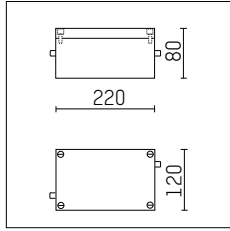

**LED-Betriebsgerät IP65**

- Konstantstrom-EVG
- Netzanschluss: Steckklemme 5x2,5 mm<sup>2</sup>
- zur Durchverdrahtung vorbereitet
- temperaturüberwacht
- vorbereitet für den Anschluss von Leuchten mit NTC-Überwachung
- Schutzart: IP65, Schutzklasse I

**LED power unit IP65**

- constant current gear
- power supply: push-wire terminal 5x2,5 mm<sup>2</sup>
- prepared for through-wiring
- temperature-controlled
- prepared for the connection of luminaires with NTC monitoring
- protection rating: IP65, protection class I

Strom / current	Leistung / power	Spannungsbereich / voltage range	Länge / length	Breite / width	Höhe / height	dimmbar / dimmable	Art.-Nr. / item-No.
700 mA	50 W	220-240 V ; 0,50-60 Hz	220 mm	120 mm	80 mm		117 091 00 721
						DALI	117 091 00 721 D
350 mA	40 W	220-240 V ; 0,50-60 Hz	220 mm	120 mm	80 mm		117 092 00 721
						DALI	117 092 00 721 D
700 mA	70 W	90-305 V ; 47-63 Hz	220 mm	120 mm	80 mm		117 093 00 721
						DALI	117 093 00 721 D
350 mA	54 W	220-240 V ; 50-60 Hz	220 mm	120 mm	80 mm		117 094 00 721
						DALI	117 094 00 721 D
700 mA	90 W	220-240 V ; 50-60 Hz	220 mm	120 mm	80 mm		117 095 00 721
						DALI	117 095 00 721 D

**Übersicht möglicher Kombinationen von LED-Leuchte und Konstantstrom Betriebsgerät.  
Overview about possible combinations of LED luminaires and constant current LED power units.**

Leuchte / luminaire	Betriebsstrom / current 350 mA			Betriebsstrom / current 700 mA	
	Spannung U max. / voltage U max.	Modulleistung / module power	LED-Betriebsgerät / LED power unit	Modulleistung / module power	LED-Betriebsgerät / LED power unit
117 032 ... 117 034 ... 117 035 ... 117 036 ...	39 V	12 W	117 092 00 721 117 092 00 721 D	25 W	117 091 00 721 117 091 00 721 D
117 042 ... 117 044 ... 117 045 ... 117 046 ...	78 V	24 W	117 092 00 721 117 092 00 721 D	50 W	117 093 00 721 117 093 00 721 D
117 052 ... 117 054 ... 117 055 ... 117 056 ...	117 V	35 W	117 094 00 721 117 094 00 721 D	75 W	117 095 00 721 117 095 00 721 D